

ProReact Digital Interface Monitor Module (DiMM)

Installation Instructions

Contents:

Important Guidelines – read before commencing installation	Page 3
General Overview	Page 4
Technical Specifications	Page 5
Installation	Page 6
- Overview	
- Connections Diagram	
Operating Modes	Page 7
- Wiring Diagram: Independent	
- Wiring Diagram: Interlock	
Useful Information	Page 9
- Leader Cable	
- Mounting Dimensions	
- Static Discharge Cautionary	
Commissioning	Page 10
- Normal Operation	
- Fault / Alarm Conditions	
Testing and Verification	Page 14
Two-wire RS-485 Modbus RTU/ASCII Communications	Page 15
Resetting the ProReact DiMM	Page 16
Compatible Products	Page 17
Glossary	Page 18

Important Guidelines

Please read this instruction leaflet thoroughly before commencing installation.

- ✓ Install the Digital Interface Monitor Module (DiMM) accordingly to meet local and country installation requirements.
- ✓ The DiMM must be installed in accordance with NFPA 70 & 72, NEC 760 (National Electric Code) and Authorities Having Jurisdiction.
- ✓ Ensure the product is installed, commissioned and maintained by qualified professionals according to good engineering practices and who have received sufficient training on the unit.
- ✓ Only use Thermocable ProReact Digital Linear Heat Detection cable with the DiMM.
- ✓ Test the Digital Linear Heat Detection cable before connecting it to the DiMM using a multimeter.
- ✓ Ensure the end of line resistor (1kohm) is securely connected at the end of each linear heat detection cable.
- ✓ If only one zone is required leave the end of line resistor (1kohm) connected across the terminals of the unused zone.
- ✓ Ensure any cable glands used are tightened to form a secure and moisture proof seal around the detection cable and any other cable in or out of the unit.



Do not exceed the maximum operating voltage of the DiMM (36Vdc).



Do not connect lengths of linear heat detection cable in 'T' connections or spurs.

General Overview

Digital Interface Monitor Module

The Thermocable ProReact Digital Interface Monitor Module (DiMM) is a dual zone module for monitoring up to two zones of Thermocable ProReact Digital Linear Heat Detection (LHD) Cable. If an overheat or fire situation triggers either zone of the Digital LHD cable the unit automatically calculates and displays the distance along the cable, in feet and metres, to the alarm point. The two zones can operate independently of each other, or in interlock mode and a separate alarm and normally

conducting fault output are provided for each zone. The unit is intended to be installed between the Digital Linear Heat Detection cable and a conventional or addressable fire alarm control panel. It has power, fault and alarm lights, as well as volt free outputs for fault and alarm, corresponding to each zone. It may also be connected to an industrial process control system using the two wire RS-485 Modbus RTU/ ASCII output.

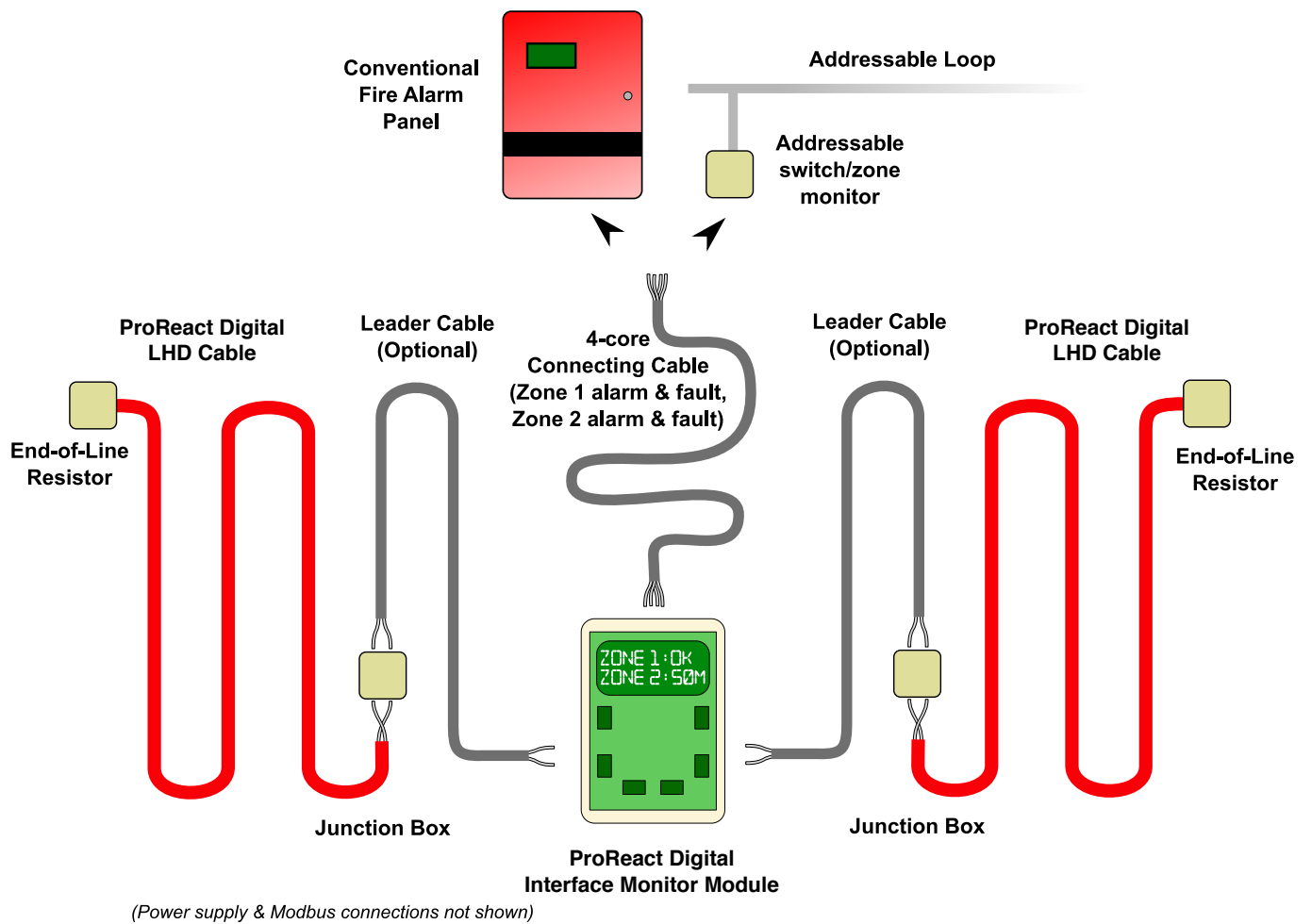

Figure 1: Typical Installation of the ProReact Digital interface Monitor Module

Technical Specifications

Thermocable Part Number:	A1349		
Thermocable Part Description:	ProReact Digital Interface Monitor Module (DiMM)		
UL Model Number:	DiMM (-M suffix M16 knockouts on bottom) (-Pg suffix PG16 knockouts on bottom)		
UL File Number:	S35680		
Revision:	1.6		
Approvals:	UL 864 10th ed.		
Enclosure:			
...Dimensions	H180mm x W120mm x D60.5mm (H7.1in x W4.72in x D2.38in)		
...Rating	NEMA 4, 4X (IP65)		
...Finish	Light Gray with clear lid		
...Display	2 line, 16 character backlit display showing zone status		
Power Requirements:	<i>All circuits power limited if powered from a power limited supply</i>		
	Min.	Nominal	Max.
...Operating Voltage (UL tested)	14Vdc	— to —	36Vdc
...Operating Voltage	12Vdc	— 24Vdc —	36Vdc
Current Consumption:	↓	↓	↓
...Normal Operation (standby)	<15mA	<7mA	<5mA
...Alarm	<40mA	<23mA	<15mA
Operating Temperature Range:	-20°C – +50°C (-4°F – +122°F)		
Terminal Blocks:			
...Spacing	5mm Rising Clamp		
...Rating	16A		
...Wire Size	0.08mm ² (28AWG) to 4mm ² (11AWG)		
Supervised Circuits:	Power, Input Zone 1 & Input Zone 2		
Inputs:	<i>Up to two Class B zones of Thermocable ProReact Digital LHD Cable</i>		
...Max Zone Length	3000m (10,000ft)		
...Min Zone Length	1m		
...End of line resistor	1kohm (included)		
...Short circuit current	0.5mA		
...Max Voltage	5V		
...Ground fault impedance	0ohms		
Outputs:			
...Communications	Two wire RS-485 Modbus RTU/ASCII		
...Sounder	2.4kHz 92dBa @ 10cm Buzzer		
...Alarm	2x Form C volt-free relay contacts (resistive, common)		
	<i>Max V</i>	30Vac or 42.4Vdc	
	<i>Max Current</i>	2A	
	<i>Max Switching Power</i>	60W, 62.5VA	
...Fault	2x Optoisolated phototransistor output (resistive, common)		
	<i>Max V</i>	35Vdc	
	<i>Max Current</i>	80mA	
	<i>Max Power Dissipation</i>	150mW	

Installation

Overview

The DiMM allows accurate location of an alarm point along a length of Thermocable ProReact Digital Linear Heat Detection (LHD) cable. It continuously monitors up to two zones of Digital LHD cable for a fault (open circuit) or an alarm (overheat or fire condition). Because of the wide range of applications that Digital LHD cable can be used for, it may not always be possible, or be too time consuming, to locate where along the cable an alarm has occurred. Using the DiMM, when an alarm occurs the distance to the overheat condition is immediately calculated and displayed on the integrated display.

If a fault is detected, the corresponding fault output stops conducting, triggering a fault at the fire alarm control panel. If an alarm is detected, the corresponding alarm output changes state, triggering an alarm at the fire alarm panel. The fault outputs also stop conducting on power loss to the unit or microprocessor fault, triggering a fault at the fire alarm control panel.

The two wire RS-485 Modbus RTU/ASCII output also outputs the current state of both zones. See the section "Modbus RTU/ASCII Communications" for more detail.

There are two primary configurations of the DiMM (see figure 1):

- 1) The Digital LHD cable can be connected directly to the DiMM
- 2) The Digital LHD cable is connected to a length of leader cable which is connected to the DiMM. In this scenario the leader cable must be "calibrated out" during commissioning of the DiMM.

Connections Diagram

Figure 3 shows the connections diagram for the DiMM unit. The unit is provided with a 1kohm end of line resistor in each zone input. If only one zone is required, leave the 1kohm resistor connected across the zone which is not in use. Otherwise the 1kohm resistor should be connected at the end of the Digital Linear Heat Detection cable.

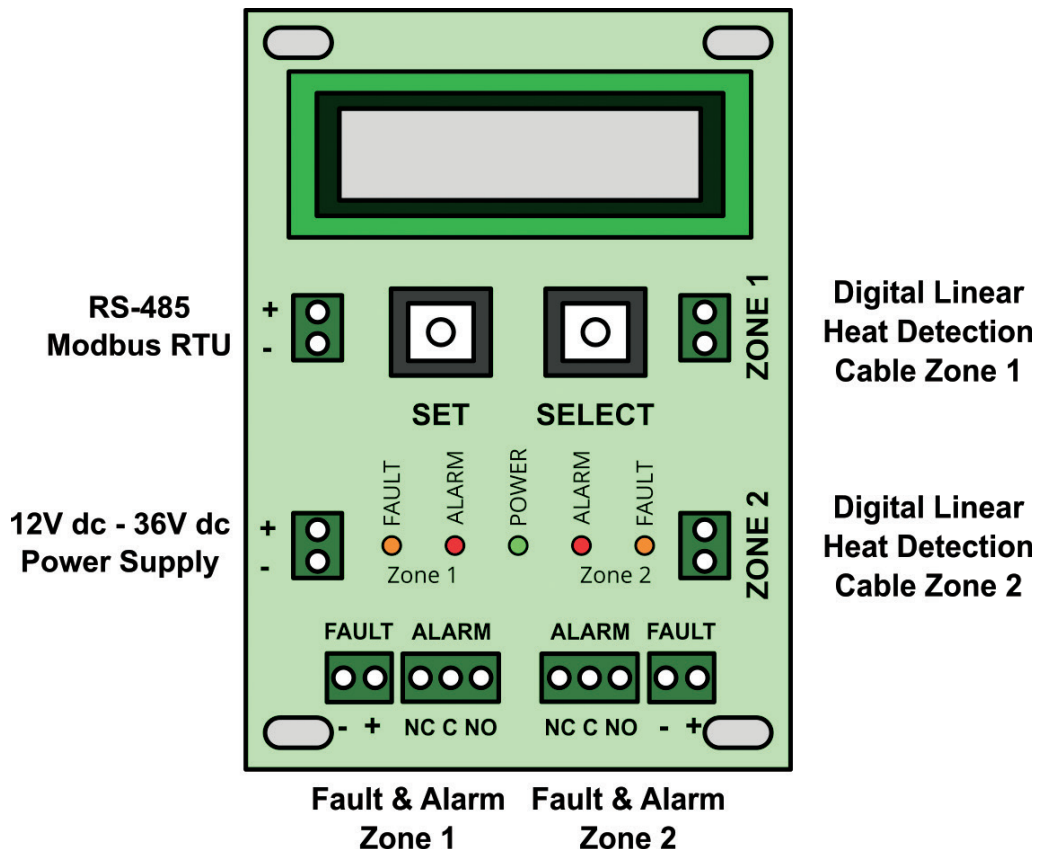
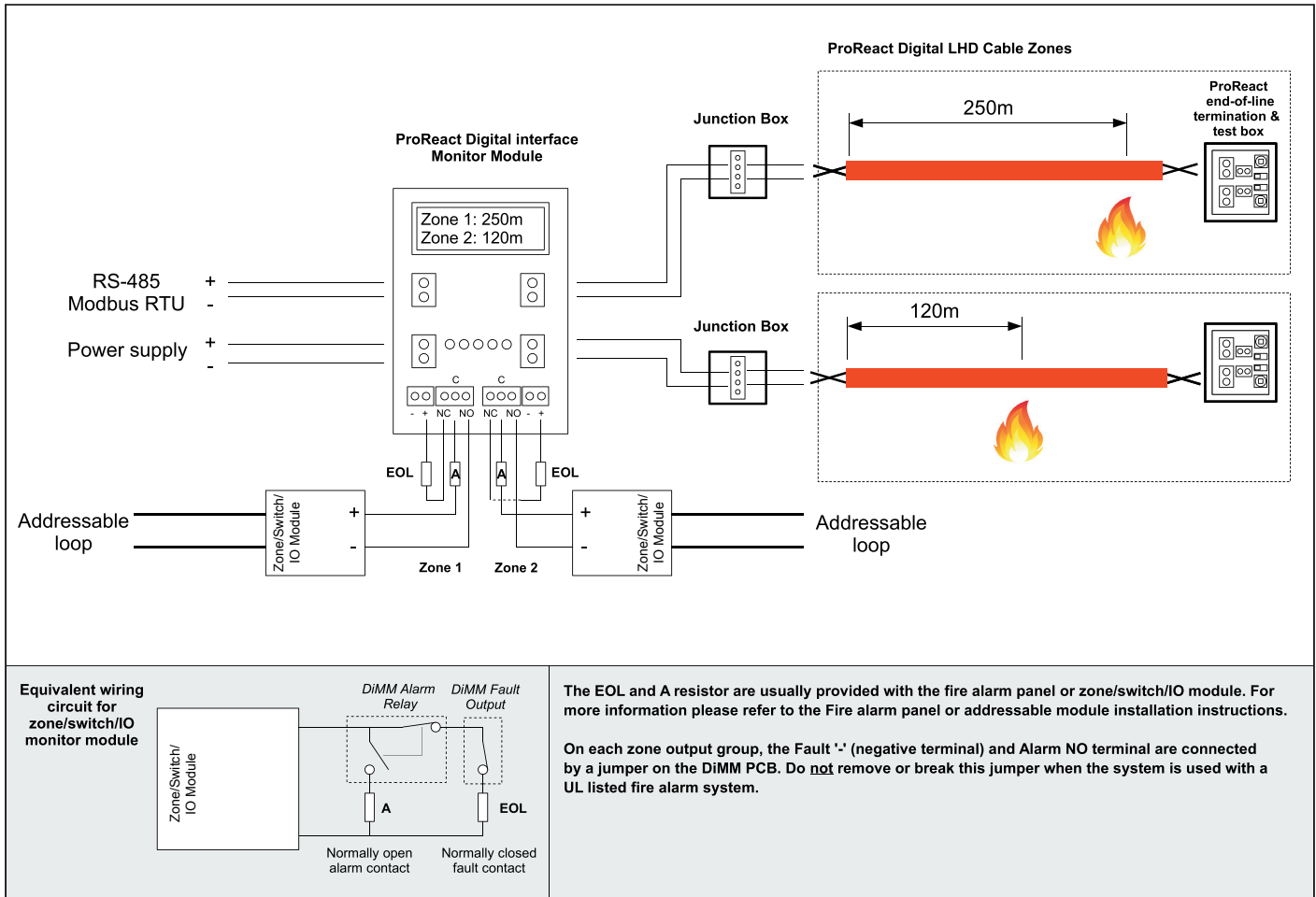

Figure 3: Wiring Diagram for the Thermocable ProReact DiMM

Operating Modes Wiring Diagram Independent

There are two operating modes for the Digital interface Monitor Module:

1. **Independent** – This is when the DiMM is used as a two zone system. When a fault or overheat condition occurs on a Digital LHD zone, the corresponding fault or alarm output respectively is triggered. The two zones operate independently and both sets of outputs should be connected to a fire alarm control panel. If the zone is not required leave the 1kohm resistor in the zone input terminals as supplied. In this mode, the two zones can either contain identical rated temperature Digital LHD cables or two different rated temperature Digital LHD cables, e.g. a 68°C in zone 1 and a 105°C in zone 2.



Operating Modes Wiring Diagram Interlock

2. **Interlock** – this mode is for applications which require a fail-safe guarantee that an alarm is only triggered when an overheat condition has been detected. This mode may also be known as coincidence detection. In this case, the same rated temperature Digital LHD cable should be attached to both zones of the DiMM. The alarm output is only activated when both Digital LHD cables trigger an alarm due to an overheat condition. If one Digital LHD cable zone input registers an alarm but the second does not, the alarm output will **not** be activated. This is to prevent an alarm if a mechanical or other issue has triggered one Digital LHD cable and not an overheat condition.

- Only use Zone 1 fault and alarm outputs in Interlock mode.
- Two linear heat detection cables with the same temperature rating must be used and a minimum of two linear heat detection cables must be installed in each protected space.
- The spacing between detection cables should be less than 0.7 times the rated linear spacing, in accordance with National Fire Alarm Code, NFPA 72.

See the ProReact Digital LHD Installation Instructions for the linear spacing specification.

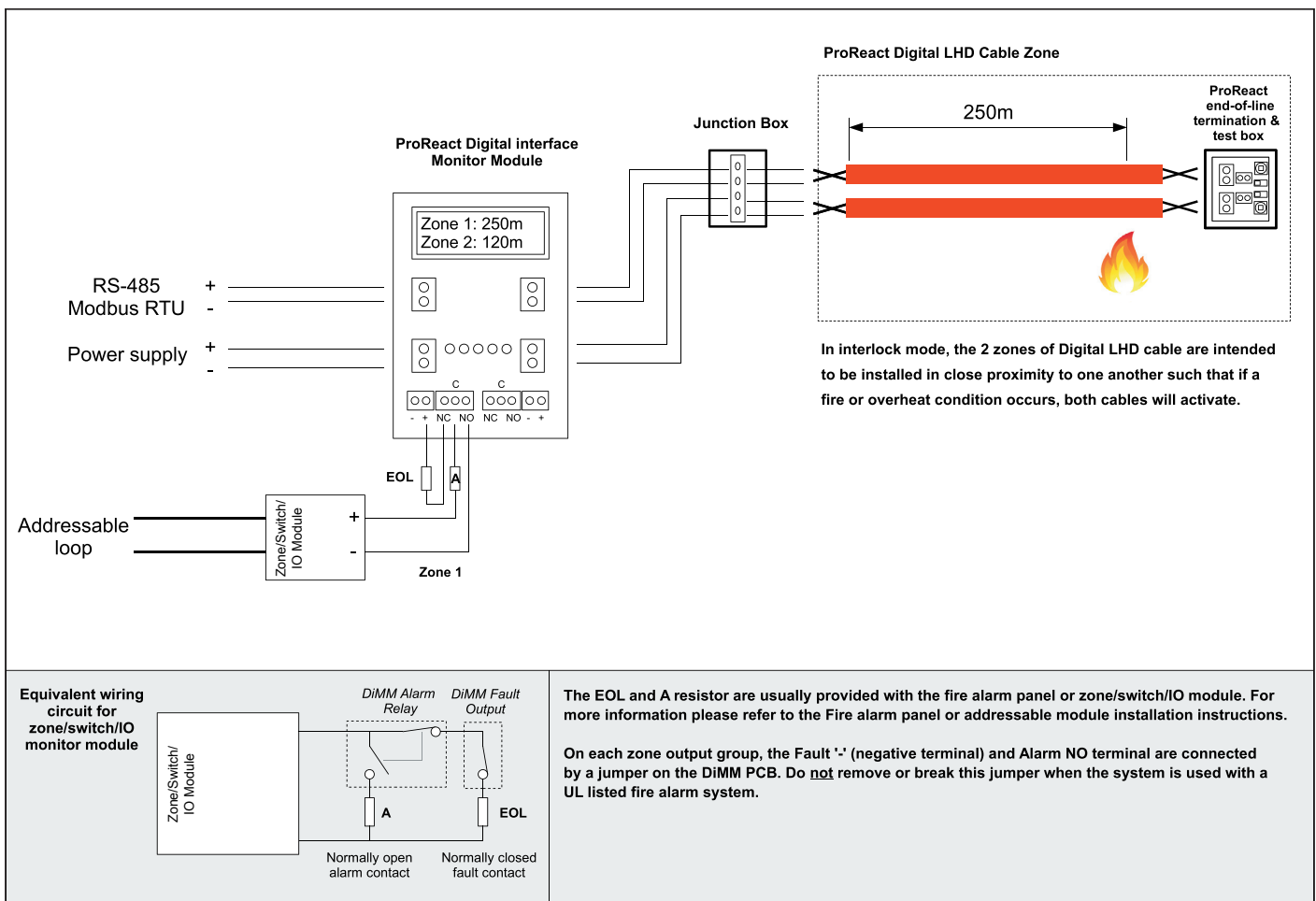

Useful Information

Leader Cable

In certain applications it may be desirable or necessary to use non-sensing leader cable between the ProReact DiMM unit and the Digital LHD cable. For example, if the the DiMM unit is located some distance away from the area protected by the Digital LHD cable. This may be required if the expected ambient temperature range, or other environmental conditions, where the Digital LHD cable is to be used is greater than the maximum ambient temperature range for the DiMM unit. (see steps 8, 9 and 10 in the Commissioning section on pages 10-11).

The maximum length of leader cable that can be used per zone is dependent upon the leader cable diameter'. The following is a guideline for typical cable sizes and maximum length:

Leader Cable Size	Max Leader Cable Length
20AWG (16x0.2mm or 0.8mm dia, copper)	1000m
22AWG (7x0.25mm or 0.6mm dia, copper)	600m
24AWG (7x0.2mm or 0.5mm dia, copper)	390m

Static Discharge Cautionary

The following items are cautionary notes that will help prevent equipment damage or malfunction caused by static discharge:

CAUTION

Static charges produce voltages high enough to damage electronic components. Follow these precautions when installing, servicing, or operating the DiMM:

- Work in a static-free area.
- Discharge any static electricity you may have accumulated.
- Discharge static electricity by touching a known, securely grounded object.
- Do not handle the printed circuit board (PCB) without proper protection against static discharge.

In the event that the DiMM malfunctions after encountering a static discharge correct operation of the unit can be restored by interrupting power to unit for a brief period (approximately 10 seconds). Setup information can be verified by following the steps in the Commissioning section (page 10 onwards). In the event of the setup information being corrupted the unit should be reset following the *Resetting the DiMM procedure*.

Mounting Dimensions

The DiMM is intended to be wall-mounted. 4 holes should be drilled according to the mounting dimensions given in figure 2. The corresponding mounting holes on the DiMM unit can be found by removing the lid of the device. The mounting holes are located adjacent to the lid screw positions. Suitable screws for the type of wall the DiMM is to be mounted on will need to be provided for separately. The maximum screw head diameter is 7mm and the maximum screw thread diameter is 4mm.

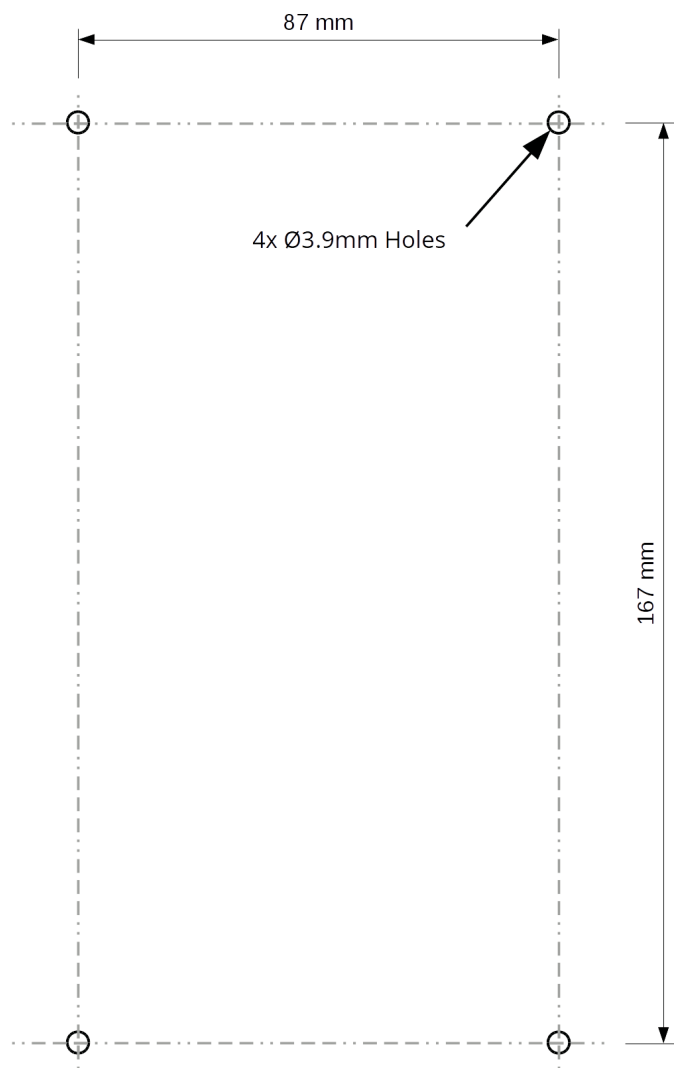

Figure 2: Mounting Dimensions for the Thermocable ProReact DiMM

Commissioning

1. After wiring the unit up (see wiring diagram) power up the device. Device will show screen including software revision number.
2. If the unit is being setup for the first time the following options will be shown. If the unit has previously been installed the display will automatically cycle through the options, showing the stored settings.
3. After the initial title screen the next screen will show a menu (see right) with three options: Load Configs, New Configs and Self Test. On a previously configured device, after 10s of no button being pressed the device will automatically proceed to loading saved configs.
4. If "Load Configs" is selected or no button has been pressed after 10s on a *previously configured device*, the screen will show "Loading Saved Configs". The previously saved parameters will then be displayed.
5. Select the operating mode. (see "Operating modes" (pages 7-8) for more detail.
Independent: the two zones operate independently of each other (default).
Interlock: Both fault outputs activate when a fault occurs on either zone 1 or zone 2. Both alarm outputs activate **only** when both Digital LHD zones trigger an alarm.
6. Select the relevant operating programme for Zone 1 based on the table below:

Alarm (or activation) temperature	Cable Set-Up					
	1	2	3	4	5	6
65°C or 68°C	✓					
75°C or 78°C		✓				
85°C or 88°C			✓			
100°C, 105°C, 110°C				✓		
185°C					✓	
230°C (VHT)						✓

7. Select the relevant operating programme for Zone 2 based on the table below:

Alarm (or activation) temperature	Cable Set-Up					
	1	2	3	4	5	6
65°C or 68°C	✓					
75°C or 78°C		✓				
85°C or 88°C			✓			
100°C, 105°C, 110°C				✓		
185°C					✓	
230°C (VHT)						✓

PROREACT DUAL
ZONE DIMM R1234

MAIN MENU
LOAD CONFIGS

LOADING SAVED
CONFIGS...

OPERATING MODE:
INDEPENDENT

Z1 CABLE TYPE:
1

In this example, Option 1 has been chosen for an alarm temperature of 68°C

Z2 CABLE TYPE:
3

In this example, Option 3 has been chosen for an alarm temperature of 88°C

Commissioning (Cont.)

8. If leader cable is connected between the Digital LHD cable and the DiMM unit and/or the LHD cable is installed in a hazardous area and IS barriers are being used, the voltage drop to the start of the LHD cable must be measured by the DiMM unit in order to ensure correct operation and accurate distance location. In order to do this, with the leader cable and/or IS barriers and LHD cable connected to the DiMM unit, short out the connection at the **start** of the LHD cable. If this is the first time this procedure is being carried out, select "Yes" and press Set to continue. If the DiMM unit is being re-commissioned and you would like to use the previously stored calibration value **without** having to short out the start of the LHD zone, press the Select button until the "Last" option is shown. Then press Set. The DiMM unit will display the last measured calibration value for confirmation.

ZONE 1 LDR CABLE
YES

9. If "Yes" was selected in step 8, the DiMM unit will then ask if the zone is ready to be calibrated. Ensure that the connection between the leader cable and/or the IS barriers and the **start** of the Digital LHD cable is securely shorted out between the two cores. When this is done, press the "Set" button to continue.

READY TO
CALIBRATE?

10. The DiMM unit will display the voltage drop across the leader cable. If necessary, press "Select" to perform the calibration measurement again. The DiMM unit will display the updated voltage drop in mV (milli-volts). The display value should be equal to approximately half the loop resistance (in ohms) from the DiMM unit, **with the short in place**. Once the voltage drop has been confirmed correct, press "Set" to continue. **Now remove the short at the start of the LHD cable.**

ZONE 2 CAL:
109 MV

11. If the Linear Heat Detection cable is connected directly to the DiMM then select No and press the Set button to continue.

ZONE 2 LDR CABLE
NO

12. Select whether you would like the alarm outputs for both zones to be latching. If set to Yes, then **if an alarm is triggered the unit will either require the power supply to be interrupted (min. 2s) or the Set button to be pressed to reset to normal once the alarm condition has been cleared.**

LATCHING OUTPUTS
NO

13. Select whether the Modbus output should be enabled. If this is not enabled then proceed to step 20.

MODBUS OUTPUT ON
YES

14. Select required Modbus type, either RTU or ASCII.

MODBUS TYPE
RTU

15. Set the Modbus address for this device (1-247).

MODBUS ADDRESS
1

16. Cycle through the possible Baud Rates for the Modbus RTU/ASCII output. (2400, 4800, 9600, 19200, 38400, 57600, 115200).

BAUD RATE
2400

Commissioning (Cont.)

17. Select the number of data bits for the Modbus RTU/ASCII output.
(7 or 8)



DATA BITS
7

18. Select the number of stop bits for the Modbus RTU/ASCII output.
(1 or 2).



STOP BITS
1

19. Select the parity for the Modbus RTU/ASCII output.
(even/odd/none).

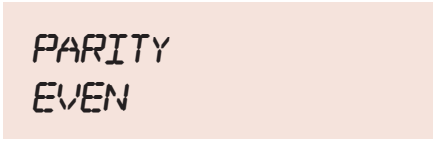

PARITY
EVEN

Normal Operation

20. Once the unit has been commissioned, the display will show the zone status. In normal operation, the display unit in independent mode will show:

Zone 1: OK
Zone 2: OK

Independent mode

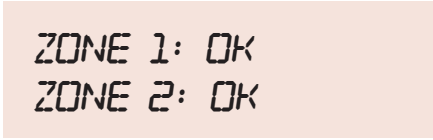

ZONE 1: OK
ZONE 2: OK

The display unit in interlock mode will show:

{Zone 1: OK
{Zone 2: OK

This indicates the two zones of LHD cable are linked and an alarm is only transmitted if both zones are triggered.

Interlock mode

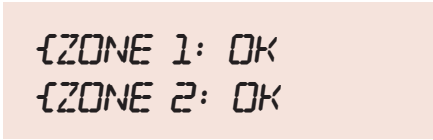

{ZONE 1: OK
{ZONE 2: OK

LED Illustration

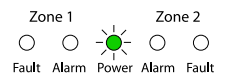
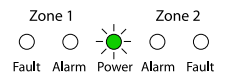

Either of the display screens above and a single flashing Power light (green colour) should be visible when ProReact DiMM unit is in normal operation.

Fault/Alarm Conditions

21. If an alarm condition occurs the DiMM automatically calculates the distance along the cable to the trigger point and first displays this value in metres.

22. The display alternates showing the distance along the cable to the trigger point in metres and in feet.

23. The unit monitors for relay faults. If an alarm condition occurs but the relay does not switch state (due to a coil failure for example) the device will go into relay fault and show the screen to the right, depending upon which zone is in fault

24. The unit monitors for interference faults when the input may be changing between alarm, ok and fault conditions, for example, too rapidly. In this case an I/F fault is displayed on the corresponding zone. Check all cable terminations are securely fastened and look for other sources of noise.

25. The unit monitors for cable faults (open circuit) and ground faults (where one conductor of Digital LHD cable may be touching bare metal at some point). An open circuit will be displayed as fault (as per zone 1 shown right). A ground fault will be shown as 'gnd flt' (as per zone 2 shown right).

26. In interlock mode, the alarm outputs are only activated when both LHD cables are triggered. If one cable triggers but not the other the display will show the distance to the alarm on the triggered zone and the corresponding alarm LED will flash slowly.

27. In interlock mode, if both cables go into an alarm, the alarm outputs will be activated and the display will show the distance to the alarm for each zone. The zone 1 and zone 2 alarm LEDs will light continuously.

LED Illustration

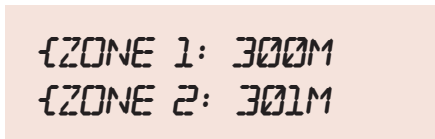
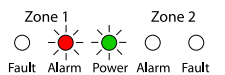
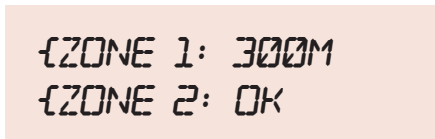
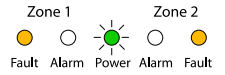
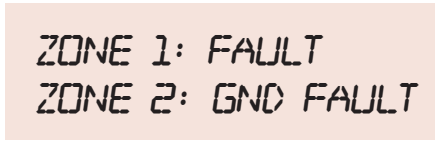
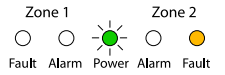
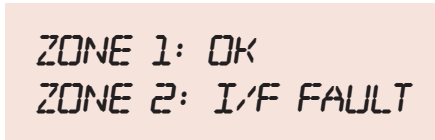
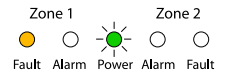
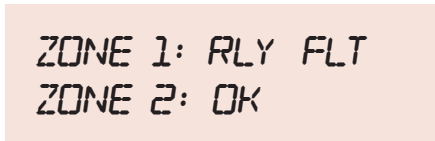
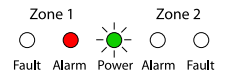
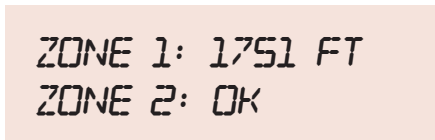
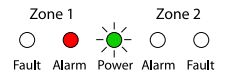
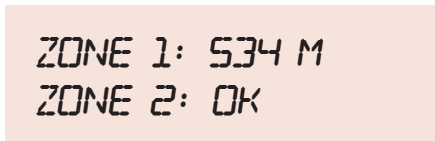

Testing & Verification

1. If self test mode is selected the device will first load the saved configs then proceed to cycle through normal operation, alarm and fault. This is to allow the installer/maintenance engineer to verify that the unit is connected to an external system correctly. The screen will flash "SELF TEST/MODE" every few seconds.

2. In self test mode the device cycles between normal operation, alarm and fault every approx. 8 seconds. In normal operation the display will show OK. The alarm relays will be off and the fault output normally conducting (on).

3. In self test mode and alarm condition the display will show alarm. The alarm relays will be on. After approx. 8 seconds the unit will go into fault condition.

4. In self test mode and fault condition the display will show fault. The fault outputs will stop conducting (off). After approx. 8 seconds the unit will return to normal condition. To exit self test mode, press and hold both SET and SELECT buttons for 10s or more until the device resets.

LED Illustration

SELF TEST
MODE

Independent mode

ZONE 1: OK
ZONE 2: OK

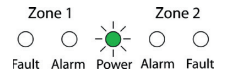

Interlock mode

{ZONE 1: OK
{ZONE 2: OK

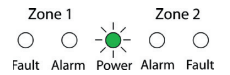

Independent mode

ZONE 1: ALM
ZONE 2: ALM



Interlock mode

{ZONE 1: ALM
{ZONE 2: ALM



Independent mode

ZONE 1: FAULT
ZONE 2: FAULT



Interlock mode

{ZONE 1: FAULT
{ZONE 2: FAULT



Two-wire RS-485 Modbus RTU/ASCII Communications

The Thermocable ProReact DiMM includes a two wire RS-485 Modbus output which can be enabled to output the status of each zone of Digital Linear Heat Detection cable. The DiMM Modbus output supports the Modbus RTU/ASCII protocol and the following functions:

- Function code 4 (Read Input Registers)

The request for reading the input registers should be constructed in the following manner:

- Address of first register to be read (16-bit)
- Number of registers to read (16-bit)

The DiMM will respond in the following manner:

- Number of bytes of register values to be read (8-bit)
- Register values (16-bits per register)

The DiMM stores the information for each zone of the Digital LHD cable in the following format:

Register	Description	Possible Values
0	Zone 1 status	-1 or 65535=fault on zone 0=zone ok 1-32767=distance in metres to trigger point
1	Zone 2 status	-1 or 65535=fault on zone 0=zone ok 1-32767=distance in metres to trigger point
2	Zone 1 cable type	1=65°C or 68°C, 2=75°C or 78°C, 3=85°C or 88°C, 4=100°C, 105°C and 110°C, 5=185°C, 6=230°C
3	Zone 2 cable type	1=65°C or 68°C, 2=75°C or 78°C, 3=85°C or 88°C, 4=100°C, 105°C and 110°C, 5=185°C, 6=230°C

If the start address plus the requested number of registers exceed 4, the DiMM will return an ILLEGAL DATA ADDRESS error.

If the request contains a function code other than those supported the DiMM will return an ILLEGAL FUNCTION error.

Resetting the ProReact DiMM

WARNING: This procedure will erase ALL stored settings and reset the Thermocable ProReact DiMM unit back to its factory default state. The cable types, leader cable calibration, latching output selection and Modbus setup will all require selecting after this procedure.

To reset the ProReact DiMM unit back to the factory state, when the unit is powered up and in normal operation (see step 20 in the Commissioning procedure), press and hold the SET and SELECT buttons for a minimum of 10 seconds continuously. While the SET and SELECT buttons are held down the power LED will flash quickly to confirm this procedure is about to take place. After approximately 10 seconds, the unit will restart and return to step 1 in the Commissioning procedure. The settings are only erased if the menu option "New Configs" is selected.

Compatible Products

Please find Thermocable's range of ProReact Digital Linear Heat Detection cable and accessories below:

Part No	Description	100m Reel			200m Reel			500m Reel			1000m Reel		
		Net Kgs	Gross Kgs	Dimms mm	Net Kgs	Gross Kgs	Dimms mm	Net Kgs	Gross Kgs	Dimms mm	Net Kgs	Gross Kgs	Dimms mm
F1065	ProReact Digital LHD 68°C PVC	2.04	2.69	Ø300 x 100	4.08	4.73	Ø300 x 100	10.20	13.00	Ø430 x 135	20.41	23.55	Ø430 x 250
F1066	ProReact Digital LHD 78°C PVC	2.04	2.69		4.08	4.73		10.20	13.00		20.41	23.55	
F1067	ProReact Digital LHD 88°C PVC	2.04	2.69		4.08	4.73		10.19	12.99		20.38	23.52	
F1068	ProReact Digital LHD 105°C PVC	1.88	2.53		3.76	4.41		9.41	12.21		18.81	21.95	
F1069	ProReact Digital LHD 185°C Nylon outer sheath	1.79	2.44		3.59	4.24		8.97	11.77		17.94	21.08	
F1070	ProReact Digital LHD 68°C Nylon outer sheath	2.64	3.29		5.28	5.93		13.21	16.01		26.42	29.56	
F1071	ProReact Digital LHD 78°C Nylon outer sheath	2.64	3.29		5.28	5.93		13.21	16.01		26.42	29.56	
F1072	ProReact Digital LHD 88°C Nylon outer sheath	2.66	3.31		5.31	5.96		13.28	16.08		26.56	29.70	
F1073	ProReact Digital LHD 105°C Nylon outer sheath	2.56	3.21		5.12	5.77		12.81	15.61		25.61	28.75	
F1074	ProReact Digital LHD 68°C Polypropylene outer sheath	2.55	3.20		5.10	5.75		12.75	15.55		25.49	28.63	
F1075	ProReact Digital LHD 78°C Polypropylene outer sheath	2.55	3.20		5.10	5.75		12.75	15.55		25.49	28.63	
F1076	ProReact Digital LHD 88°C Polypropylene outer sheath	2.50	3.15		4.99	5.64		12.48	15.28		24.97	28.11	
F1077	ProReact Digital LHD 105°C Polypropylene outer sheath	2.46	3.11		4.92	5.57		12.29	15.09		24.58	27.72	
F1078	ProReact Digital LHD 68°C Stainless steel outer braid	3.29	3.94		6.58	7.23		16.44	19.24		Ø430 x 250		
F1079	ProReact Digital LHD 78°C Stainless steel outer braid	3.29	3.94		6.58	7.23		16.44	19.24				
F1080	ProReact Digital LHD 88°C Stainless steel outer braid	3.29	3.94		6.57	7.22		16.43	19.23				
F1081	ProReact Digital LHD 105°C Stainless steel outer braid	3.13	3.78		6.26	6.91		15.64	18.44				
F1082	ProReact Digital LHD 185°C Stainless steel outer braid	3.04	3.69	6.08	6.73	15.21	18.44						
F1124	ProReact Plus Digital LHD 65°C LSZH coating	2.28	2.93	4.56	5.21	11.40	14.20	22.81	25.95				
F1125	ProReact Plus Digital LHD 75°C LSZH coating	2.28	2.93	4.56	5.21	11.40	14.20	22.81	25.95				
F1126	ProReact Plus Digital LHD 85°C LSZH coating	2.28	2.93	4.56	5.21	11.39	14.19	22.78	25.92				
F1127	ProReact Plus Digital LHD 110°C LSZH coating	2.12	2.77	4.24	4.89	10.61	13.41	21.21	24.35				
F1128	ProReact Plus Digital LHD 65°C Stainless steel outer braid on LSZH coating	3.53	4.18	7.06	7.71	17.64	20.44	Ø430 x 250					
F1129	ProReact Plus Digital LHD 75°C Stainless steel outer braid on LSZH coating	3.53	4.18	7.06	7.71	17.64	20.44						
F1130	ProReact Plus Digital LHD 85°C Stainless steel outer braid on LSZH coating	3.53	4.18	7.05	7.70	17.63	20.43						
F1131	ProReact Plus Digital LHD 100°C Stainless steel outer braid on LSZH coating	3.37	4.02	6.74	7.39	16.84	19.64						
F1132	ProReact VHT Digital LHD Silicone	4.25	7.05	Ø430 x 135	8.50	11.40	Ø430 x 135			21.25	24.39	Ø430 x 250	
F1133	ProReact VHT Digital LHD Stainless steel outer braid on Silicone	5.53	8.33	Ø430 x 135	11.10	14.00	Ø430 x 135	27.75	30.89	Ø430 x 250			
A1349	ProReact Digital interface Monitor Module	673g		180 x 120 x 61									
A1343	LHD Junction Box Polycarbonate w/5 DIN Rail mounted terminals & 2 cable glands	240g		94 x 94 x 57									
A1385	ProReact Digital LHD end-of-line box with test facility	280g		94 x 94 x 57									

Alternative materials, additional accessories or other lengths of cable other than those shown above are available upon request. Please email info@thermocable.com for more information.

Glossary

Alarm condition – A fire or overheat around the Digital LHD cable which activates the cable and triggers the DiMM unit.

Cable glands – Used to form a dust-proof and weatherproof seal around a cable entering the DiMM unit.

Digital linear heat detection cable – a sensing cable comprised of a pair of twisted low resistance conductors that fuse together at a specific temperature and induce an alarm on a fire panel or interface module.

End of line resistor – A component which allows a residual current flow through a circuit to monitor the integrity of the circuit. In the event of a break in the circuit, current will stop flowing completely and a trouble or fault signal will be triggered.

Fault condition – A break in one or both cores of the Digital LHD cable or a malfunction of the DiMM unit.

Ground Fault – A fault caused by current flowing into or out of the intended circuit path. For example, may be caused if a core of the Digital LHD cable touches metal somewhere along its length. The DiMM unit triggers a ground fault if the current flowing out of the Zone + terminal does not equal the current flowing into the Zone – terminal.

Independent mode – The mode on the DiMM unit where both zones operate separately. Each zone can trigger a fault or alarm, or be in the normal state, regardless of the state of the other zone.

Interlock mode – The mode on the DiMM unit where the alarm relay outputs will only activate when both Digital LHD cables go into alarm. If one cable triggers but not the other, the alarm relay outputs will not be triggered.

Junction box – A secure, dust-proof and weatherproof enclosure to protect a join between two lengths of Digital LHD cable or a length of Digital LHD cable and leader cable.

Leader cable – A non-temperature sensing cable which transmits the signals between two components in the system, e.g. the DiMM unit and the Digital LHD cable. Does not provide fire detection and may be fire-rated to continue functioning even in a fire condition.

Two-wire RS-485 Modbus RTU/ASCII Communications – An industry standard, signalling protocol used to communicate information between components in a system, for example a SCADA system or PLC. Often used to provide more information to be communicated than simple open or closed status communicated by a relay output.

Zone – a single circuit of ProReact linear heat detection cable connected across either a ProReact DiMM or a fire panel and an end of line resistor



Call: +44 1274 882359
www.thermocable.com

Email: info@thermocable.com
Thermocable (Flexible Elements) Ltd,
Pasture Lane, Bradford, BD14 6LU
United Kingdom

